



SMARTWIRE™ CUSTOM ORDER CATALOG

ENGINEERED PRODUCTS

EP001PG - 1016

See product patents at:
www.shurco.com/patents

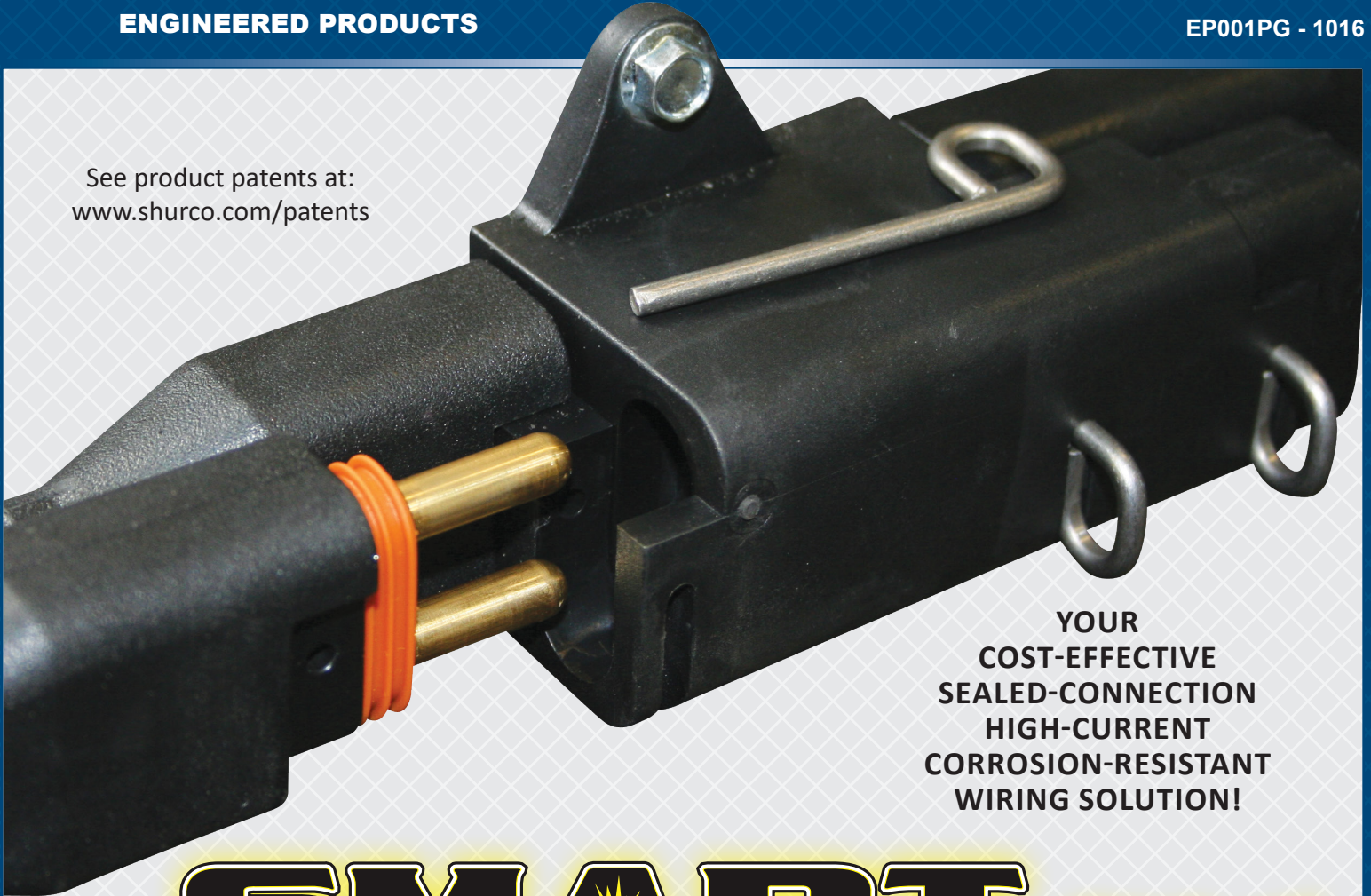

**YOUR
COST-EFFECTIVE
SEALED-CONNECTION
HIGH-CURRENT
CORROSION-RESISTANT
WIRING SOLUTION!**

SMART WIRE™

A SHUR-CO® EXCLUSIVE PRODUCT

NO OTHER SOLUTION LIKE THIS AVAILABLE ANYWHERE!

KEY FEATURES

- Sealed Connectors Eliminate Wire Corrosion
- No Wiring Stripping or Crimping Necessary for Installation
- Allows for Easy Expansion to Other Shur-Co® Electric Products
- Wire Harness with Molded Connectors and Automotive Silicone Seals to Eliminate Wire Corrosion
- Precision-Machined Brass Pins
- Available in 6- and 4-Gauge Wire



www.SHURCO.com

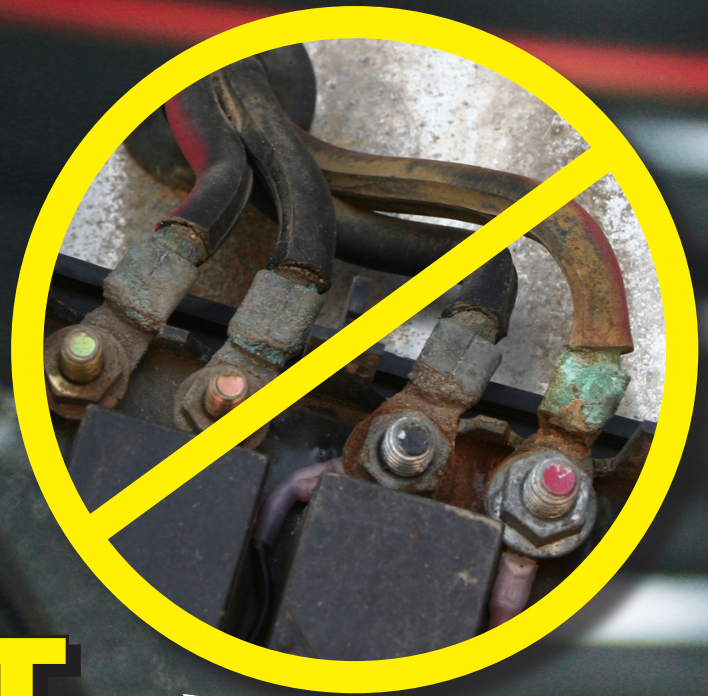

YOU WON'T GET SHORTED WITH **SMART** *WIRE*TM

- Cost Effective
- Sealed Connections
- High Current
- Corrosion Resistant

INDEX

KEY FEATURES.....	3
WIRE SPECIFICATIONS.....	4
SAMPLE WIRING CONFIGURATIONS.....	5
ORDERING INSTRUCTIONS.....	6
ORDER FORM.....	7
WIRE TERMINATION OPTIONS.....	8
WIRE TYPE OPTIONS.....	10
ACCESSORIES.....	11
TERMS AND CONDITIONS.....	15

KEY FEATURES

1. Silicone Seals

SMARTwire™ plugs and sockets utilize automotive-grade silicone seals to prevent water intrusion. Capable of temporary immersion, these connectors can survive harsh environments including off-road applications and exposure to road salt and de-icing chemicals.

3. Brass Pins and Sockets

The pins and sockets in our SMARTwire™ high-current connectors are CNC machined to close tolerances, guaranteeing a tight, low-resistance connection every time. These connectors have the same resistance as the 6-gauge cable, so you won't see additional voltage loss.

2. Molded Plugs

Shur-Co® high-current plugs and sockets are over-molded directly onto the 4- or 6-gauge cable. This produces a water-proof seal at the back of the plug, preventing water intrusion along the cable.

4. Wires and Cables

Shur-Co® wire and cable materials were selected for high flexibility, chemical resistance and wide temperature range. We use high-strand count copper conductors in our 4- and 6-gauge cables, allowing easier routing and tight radius bends.

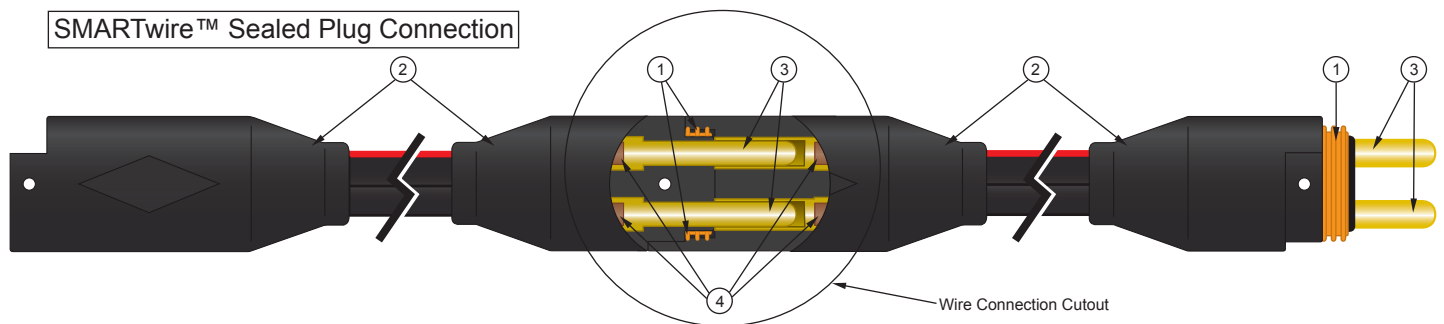

Locking Pins

SMARTwire™ high-current connectors have through holes to accept stainless locking pins. The locking pins prevent connector separation which can occur under high-shock loads or when the cables get covered with mud or ice.

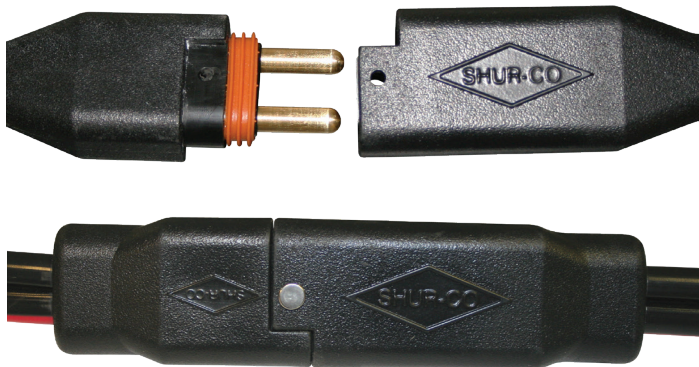

Easy Installation and Expansion

SMARTwire™ cables come fully terminated – no more stripping and crimping. You select the length, wire gauge and connectors or terminations to fit your application. When you need to connect to more than one device, our fully sealed 3-way Harness Junction Block converts one input to 3 outputs. It utilizes our precision-machined, low-resistance pins and sockets and our stainless locking pins.



WIRE SPECIFICATIONS AND SUGGESTED APPLICATIONS

SMARTwire™ Specifications

Voltage Rating	38 volts DC max
Current Rating	100 amps continuous, 200 amps peak (for no more than 10 seconds)
Connector Style	Over-molded 2-conductor with silicone gasket seal and locking pin
Contact Style	Precision-turned brass pins and sockets
Connector Sealing	Immersion tested to 12" water depth
Wire Gauges Available	4AWG and 6AWG
3-Way Junction Block Available	Splitter module available to supply power to multiple accessories
Patents	Active and pending patents can be found at www.shurco.com/patents

Suggested Applications

Truck and Trailer Accessories	Wire all your accessories including spot lights, winches, EMS light bars and more while keeping your electric connections protected.
Marine Accessories	Operate all your accessories, including trolling motors, lights, fish finders, boat lifts and more while ensuring the connectors remain dry and secure.
Charging Vehicles and Scooters	Keep moving and feel confident your mode of transportation will be properly charged* when you need it.
Snow Plow Lighting and Actuators	Have the peace of mind that your snow removal equipment will have power when you need it in the harshest environments.
ATV Winch Power	Keep your ATV winch and other electric accessories ready for work or recreation.

**Use of a properly operating and maintained charger must be used. Shur-Co® is not responsible for undercharging due to the charger not working or not maintained properly. Your battery charger must be properly rated for your application*



MARINE ACCESSORIES*

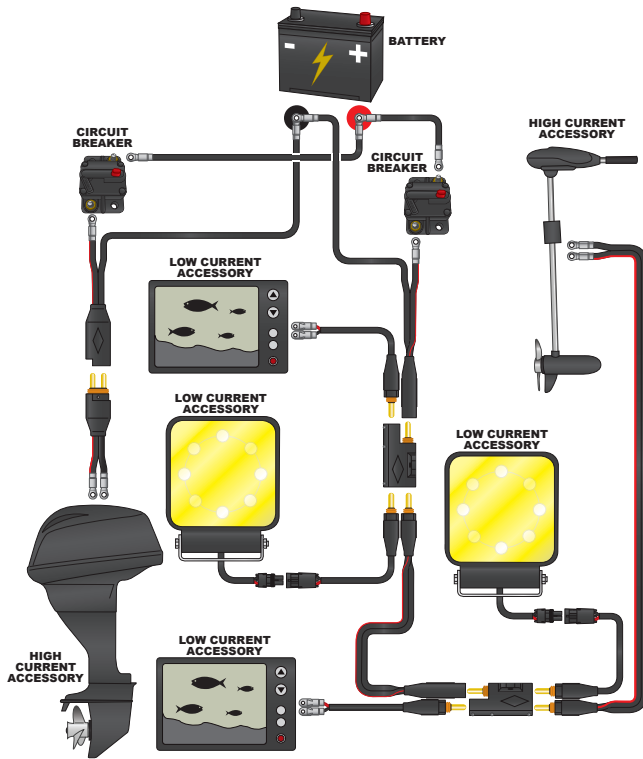

TRUCK ACCESSORIES*

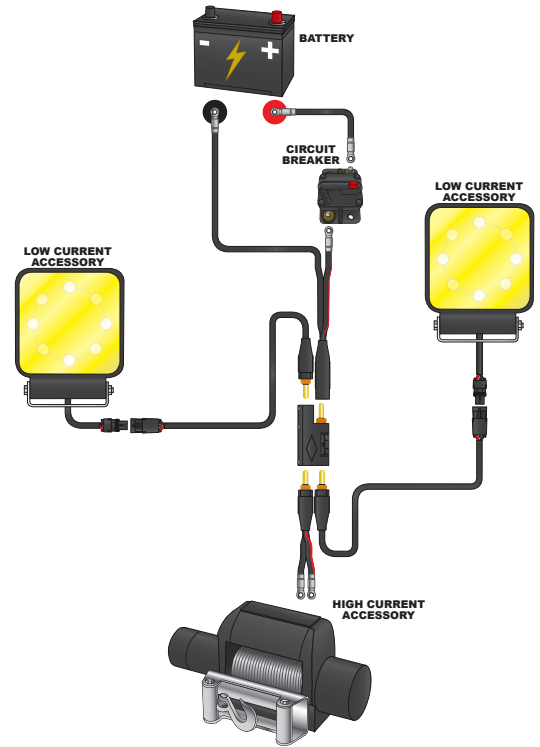

SALT SPREADER ACCESSORIES*

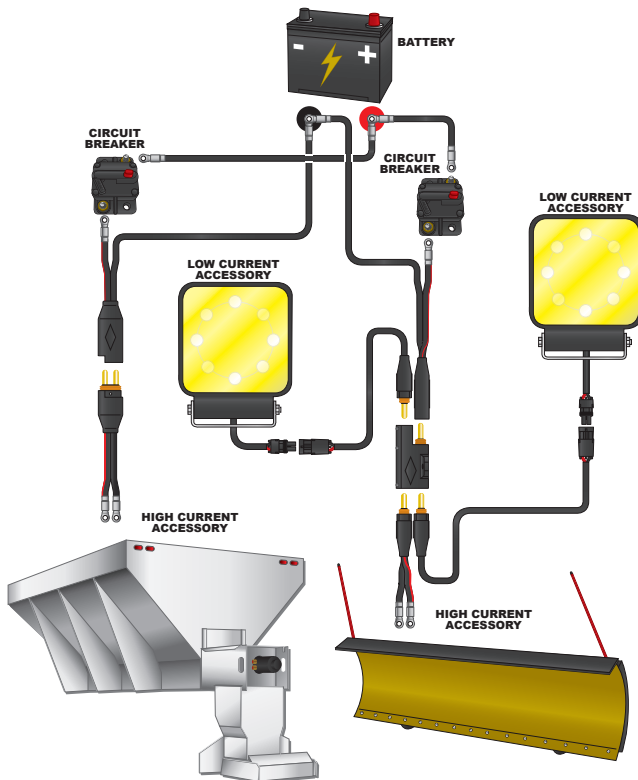

TRUCK AND TRAILER ACCESSORIES*

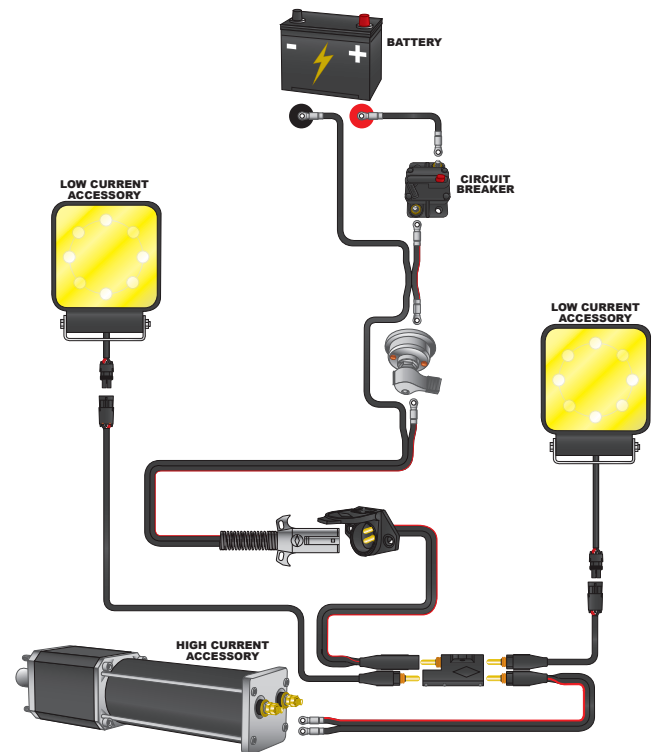

*The sample wiring configurations are for illustration purposes only. Contact the manufacturer of your accessories for specific wiring requirements.

BUILDING YOUR CUSTOM SMARTwire™ PART NUMBER

Wire Termination #1



ITEM NO.
02

WIRE TERMINATION OPTIONS

CONNECTORS		
ITEM	DESCRIPTION	PAGE
01	SMARTwire™ Male	8
02	SMARTwire™ Female	8
03	2-Pole Socket	8
04	2-Pole Plug	8
RING TERMINALS		
ITEM	DESCRIPTION	PAGE
05	#10 Ring w/Heat Shrink	9
06	1/4" Ring w/Heat Shrink	9
07	5/16" Ring w/Heat Shrink	9
08	3/8" Ring w/Heat Shrink	9
09	1/2" Ring w/Heat Shrink	9
BLUNT		
ITEM	DESCRIPTION	PAGE
10	Blunt Wire	9
11	Stripped and Split Wire	9

Wire Type & Length

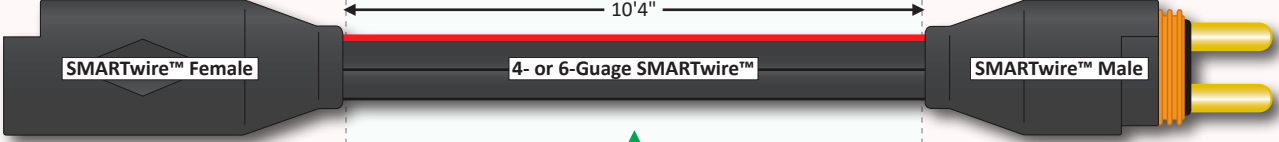

ITEM NO. WIRE LENGTH*
02 - **1004**

FEET INCHES

WIRE TYPE OPTIONS

HIGH CURRENT		
ITEM	DESCRIPTION	PAGE
01	4-Gauge SMARTwire™	10
02	6-Gauge SMARTwire™	10

Wire Termination #2

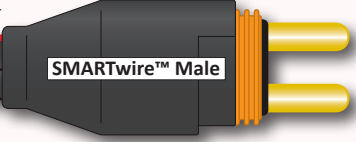

ITEM NO.
01

WIRE TERMINATION OPTIONS

CONNECTORS		
ITEM	DESCRIPTION	PAGE
01	SMARTwire™ Male	8
02	SMARTwire™ Female	8
03	2-Pole Socket	8
04	2-Pole Plug	8
RING TERMINALS		
ITEM	DESCRIPTION	PAGE
05	#10 Ring w/Heat Shrink	9
06	1/4" Ring w/Heat Shrink	9
07	5/16" Ring w/Heat Shrink	9
08	3/8" Ring w/Heat Shrink	9
09	1/2" Ring w/Heat Shrink	9
BLUNT		
ITEM	DESCRIPTION	PAGE
10	Blunt Wire	9
11	Stripped and Split Wire	9

*Wire length does not include the added length of wire termination connectors and/or ring terminals.

CONTACT INFORMATION

NAME _____

BUSINESS _____

ADDRESS _____ CITY _____ STATE _____ ZIP _____

EMAIL _____ PHONE (____) _____ FAX (____) _____

DESCRIBE YOUR INTENDED USE

ORDER DETAILS

WIRE ORDER EXAMPLE

CUSTOM SMARTwire™ PART NUMBER: 02 - 02 - 1004 - 01

QUANTITY: 10

WIRE ORDER #1

CUSTOM SMARTwire™ PART NUMBER: - - -

QUANTITY: _____

WIRE ORDER #2

CUSTOM SMARTwire™ PART NUMBER: - - -

QUANTITY: _____

WIRE ORDER #3

CUSTOM SMARTwire™ PART NUMBER: - - -

QUANTITY: _____

WIRE ORDER #4

CUSTOM SMARTwire™ PART NUMBER: - - -

QUANTITY: _____

WIRE ORDER #5

CUSTOM SMARTwire™ PART NUMBER: - - -

QUANTITY: _____

Fax 605-665-0501 Salesperson _____

ITEM NO.
01

SMARTwire™ Dual Male

Voltage Rating	38 volts DC max
Current Rating	100 amps continuous, 200 amps peak (for no more than 10 seconds)
Connector Style	Over-molded 2-conductor with silicone gasket seal and locking pin
Contact Style	Precision-turned brass pins and sockets
Connector Sealing	Immersion tested to 12" water depth
Measurements	H: 1.375"; L: 3.512"; W: .813"
Mates With	SMARTwire™ Dual Female & SMARTwire™ Junction Block

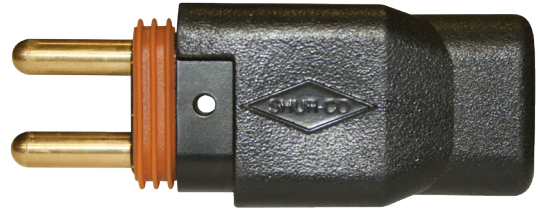

NOT TO SCALE.

ITEM NO.
02

SMARTwire™ Dual Female

Voltage Rating	38 volts DC max
Current Rating	100 amps continuous, 200 amps peak (for no more than 10 seconds)
Connector Style	Over-molded 2-conductor with silicone gasket seal and locking pin
Contact Style	Precision-turned brass pins and sockets
Connector Sealing	Immersion tested to 12" water depth
Measurements	H: 1.375"; L: 3.453"; W: .813"
Mates With	SMARTwire™ Dual Male & SMARTwire™ Junction Block



NOT TO SCALE.

ITEM NO.
03

2-Pole Vertical Socket

Voltage Rating	38 volts DC max
Current Rating	100 amps continuous, 200 amps peak (for no more than 10 seconds)
Connector Style	Vertical pins
Contact Style	Precision-turned brass
Mates With	2-Pole Vertical Plug



NOT TO SCALE.

ITEM NO.
04

2-Pole Vertical Plug

Voltage Rating	38 volts DC max
Current Rating	100 amps continuous, 200 amps peak (for no more than 10 seconds)
Connector Style	Vertical pins
Contact Style	Precision-turned brass
Mates With	2-Pole Vertical Socket



NOT TO SCALE.

ITEM NO. **05** #10 Ring Terminal w/Heat Shrink



NOT TO SCALE.

ITEM NO. **06** 1/4" Ring Terminal w/Heat Shrink



NOT TO SCALE.

ITEM NO. **07** 5/16" Ring Terminal w/Heat Shrink



NOT TO SCALE.

ITEM NO. **08** 3/8" Ring Terminal w/Heat Shrink



NOT TO SCALE.

ITEM NO. **09** 1/2" Ring Terminal w/Heat Shrink



NOT TO SCALE.

ITEM NO. **10** Blunt Wire

Strip Length	0.00"
Slit Length	0.00"



NOT TO SCALE.

ITEM NO. **11** Stripped and Split Wire

Strip Length	0.50"
Slit Length	1.75"



NOT TO SCALE.

ITEM NO.
01

4-Gauge SMARTwire™

Voltage Rating	38 volts DC max
Current Rating	130 amps continuous, 200 amps peak (for no more than 10 seconds)
Insulation Colors	Black/red
Conductor	Multi-stranded
Length	Up to 30' in 5' increments, up to 100' in 10' increments*

*Minimum quantities may be required.

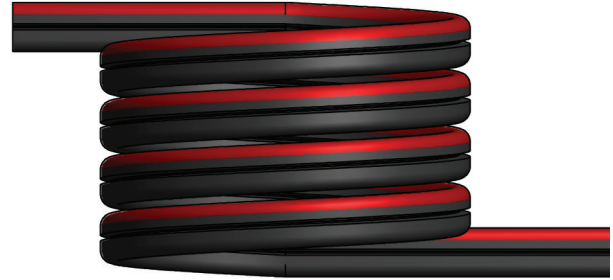

NOT TO SCALE.

ITEM NO.
02

6-Gauge SMARTwire™

Voltage Rating	38 volts DC max
Current Rating	100 amps continuous, 200 amps peak (for no more than 10 seconds)
Insulation Colors	Black/red
Conductor	Multi-stranded
Length	Up to 30' in 5' increments, up to 100' in 10' increments*

*Minimum quantities may be required.

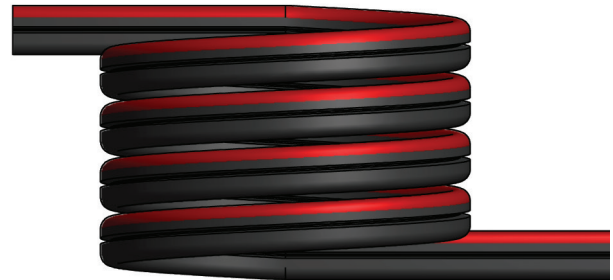

NOT TO SCALE.

ITEM NO.
01

Harness Junction Block/Splitter Kit

Voltage Rating	38 volts DC max
Current Rating	100 amps continuous, 200 amps peak (for no more than 10 seconds)
Connector Style	Over-molded 2-conductor with silicone gasket seal and locking pin. Includes one "power in" connector and 3 "power out" connectors.
Contact Style	Precision-turned brass pins and sockets
Connector Sealing	Immersion tested to 12" water depth
Measurements	H: 2.988"; L: 3.531"; W: 1.813"
Mates With	SMARTwire™ Dual Male & SMARTwire™ Dual Female
Includes	1-Harness Junction Block/Splitter (1704695), 1-Wire Harness Rubber Plug (1704717), 2-Harness Lock Pin - Long (1704696), 1-Harness Lock Pin - Short (1704711) and 2-Self-Tapping Screw (1704388)
Shur-Co® P/N	1120849



NOT TO SCALE.



ITEM NO.
02

Wire Harness Rubber Plug

Mates With	SMARTwire™ Junction Block/Splitter*
Shur-Co® P/N	1704717

*Fills unused ports on Harness Junction Block/Splitter.

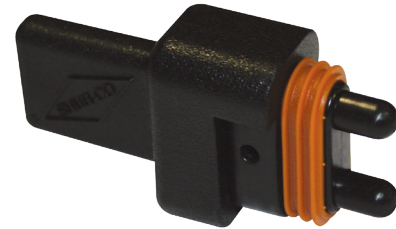

NOT TO SCALE.

ITEM NO.
03

Harness Lock Pin - Long

Works With	SMARTwire™ Junction Block/Splitter
Shur-Co® P/N	1704696



NOT TO SCALE.

ITEM NO.
04

Harness Lock Pin - Short

Works With	SMARTwire™ Junction Block/Splitter
Shur-Co® P/N	1704711



NOT TO SCALE.

ITEM NO.
04

Harness Lock Pin - Blunt

Works With	SMARTwire™ Male & SMARTwire™ Female
Shur-Co® P/N	1704751



NOT TO SCALE.

ITEM NO.
06

Master Disconnect Rotary Switch

Voltage Rating	38 volt
Current Rating	100 amps continuous
Termination Type	3/8" stud
Shur-Co® P/N	1704283



NOT TO SCALE.

ITEM NO.
07

40 AMP Modified-Reset Circuit Breaker

Voltage Rating	12 volt
Current Rating	40 amp
Reset Method	Type II - modified
Termination	#10-32 thread
Shur-Co® P/N	1704354

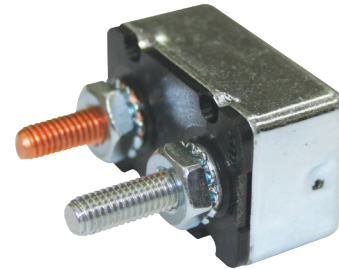

NOT TO SCALE.

ITEM NO.
08

SMARTwire™ to Weather Pack* Assembly

Voltage Rating	12-36 volt
Current Rating	20 amp
Wire Gauge	14 gauge
Termination	SMARTwire™ Dual Male & Weather Pack Plug
Length	Approx. 12"
Shur-Co® P/N	1122690

**Shur-Co, LLC is not related to or affiliated with J.R. Greenleaf & Company or White Products Division.*

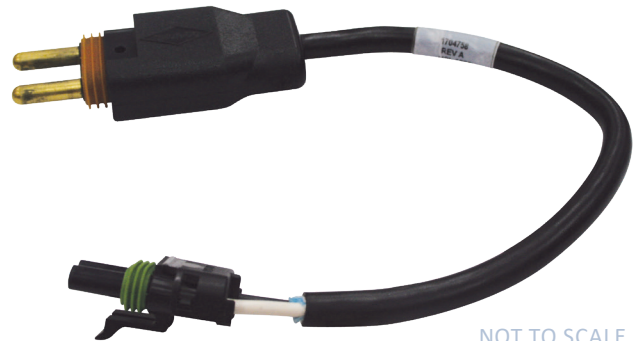

NOT TO SCALE.

ITEM NO.
09

SMARTwire™ to Blunt End Wire Assembly

Voltage Rating	12-36 volt
Current Rating	20 amp
Wire Gauge	14 gauge
Termination	SMARTwire™ Dual Male & Blunt End
Length	Approx. 12"
Shur-Co® P/N	1704758



NOT TO SCALE.

ITEM NO.

10

Rubber Grommet - Narrow

Dimensions	D: 1.125"; W: .344"
Skin Thickness	.094"
Shur-Co® P/N	1704721

**Compatible with 6-gauge SMARTwire™.*



NOT TO SCALE.

ITEM NO.

11

Rubber Grommet - Thick

Dimensions	D: 1.125"; W: .625"
Skin Thickness	.250"
Shur-Co® P/N	1704722

**Compatible with 6-gauge SMARTwire™.*



NOT TO SCALE.

ITEM NO.
17

LiteALL™ LED Work Light

Supply Voltage	10-30 volts DC (12 volts nominal)
LED Power	24 watts
Light Output	1600 lumens
Current Draw	1.8A at 12 volts DC; 0.9A at 24 volts DC
Beam Pattern	Floodlight (60°)
Environmental Rating	IP 67
LED Life	30,000 hours estimated
Mounting	Adjustable SS mounting bracket (included)
Housing Size	5.1" x 4.3" x 1.8"
Housing Material	Die-cast aluminum
Housing Color	Black
Lens Material	PMMA
Power Cable	13' jacketed cable with molded 2-way trailer connector

Wire Termination Options

P/N	Terminations
1704719	Molded 2-Way Connector
1122706	Weather Pack* Connector

*Shur-Co, LLC is not related to or affiliated with J.R. Greenleaf & Company or White Products Division.

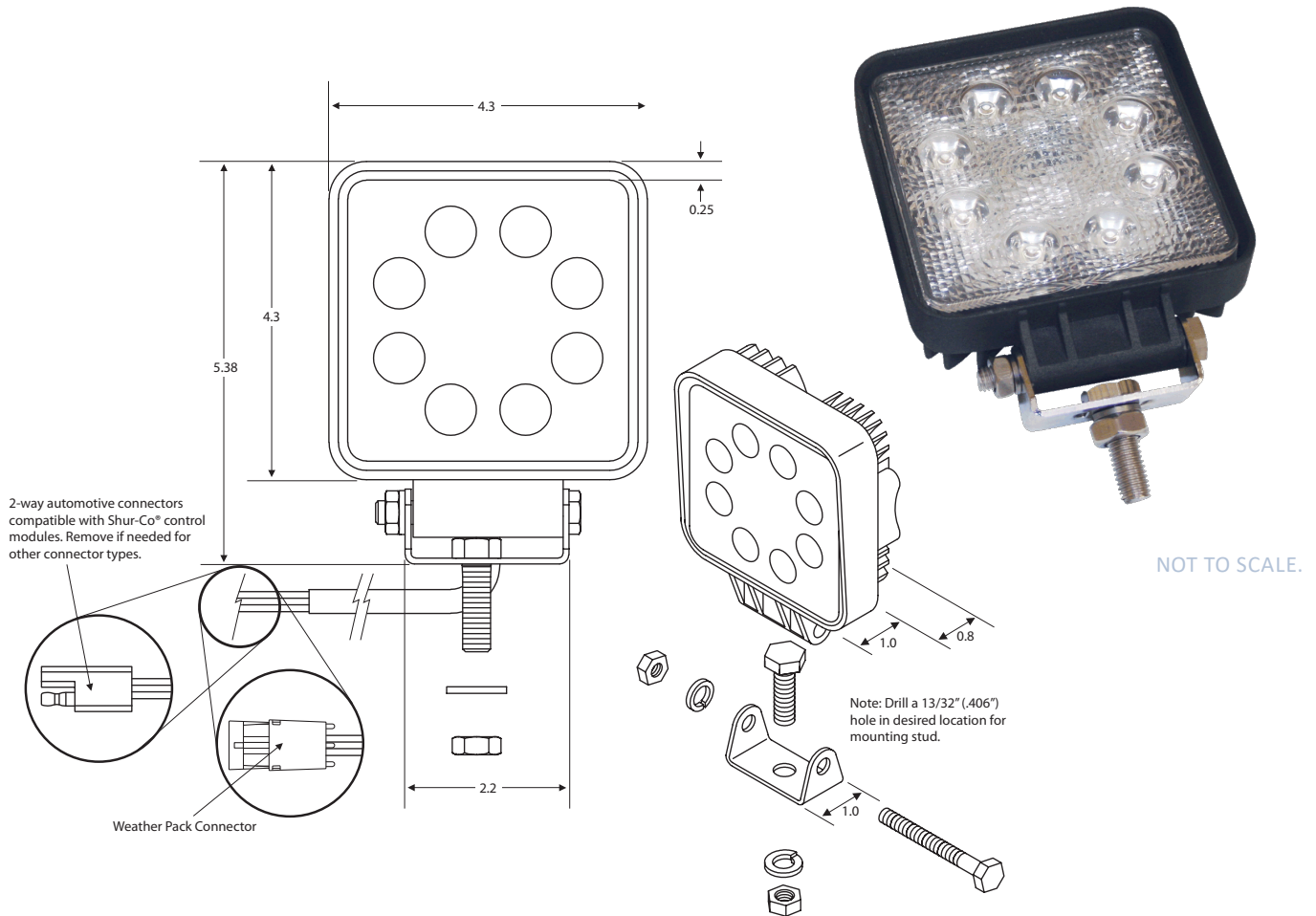

TERMS AND CONDITIONS

ORDERS

All orders are subject to written acceptance by Shur-Co®, LLC, P.O. Box 713, 2309 Shur-Lok Street, Yankton, South Dakota 57078-0713. We are required by law to collect sales tax and F.E.T. taxes on products shipped to states where applicable. If tax exempt, a copy of your tax exempt certificate must accompany your order.

EXPEDITE FEE/ADDED CHARGES

In-stock parts orders placed by 10:00 a.m. (Central Time) normally ship the same day. (This varies with quantity/size of the order.) Standard lead time on tarps and hardware kits is generally five to seven working days; however, if you request that your order of tarps, hardware kits and/or complete tarp systems be expedited earlier than the normal lead time, there will be an additional charge of \$25. This fee is in addition to shipping and handling charges.

NOTE: We have no control over delivery dates – only ship dates.

SHIPPING

All orders are shipped F.O.B. from Shur-Co®, LLC, Yankton, SD; Denver, CO; Ravenna, OH; Fort Dodge, IA; Decatur, IL; Brookshire, TX; West Fargo, ND; or Lexington, MI or Stuart, FL. There will be no full freight allowed or prepaid shipment accepted unless quoted and approved in writing prior to acceptance of the order. All shipments are made by most reasonable means in accordance with size and weight of order, unless specific routing instructions are furnished by the customer. Shipments are made daily via U.P.S. and common carrier. Claims for shortages must be made within 10 days. All claims for damages or loss in transit must be made with the carrier. No collect calls will be accepted. To ensure delivery of orders, we need your full street address and phone number. When you receive your shipment, examine it carefully. Be sure that all cartons listed on the delivery sheet are accounted for. Large items, such as steel tubing, may be packaged separately. If a carton is damaged, open it and inspect the contents before signing for delivery. If merchandise is damaged, describe the damage on the delivery receipt. Failure on your part to document damaged or missing merchandise on the delivery receipt releases the carrier of liability; repair or replacement will be the customer's responsibility.

CREDIT TERMS

Shipments are made on a cash basis – no C.O.D.s. We accept American Express, Discover, VISA, MasterCard and checks by phone or mail. Prices are subject to change without notice.

RETURN POLICY

All sales are final. See WARRANTY section at right for information on warranty returns.

NOTE: No person is authorized to modify foregoing conditions of sale whatsoever. All prices, product listings, sizes, weights and manufacturing details in this catalog are subject to change without notice. Any non-standard component requiring special engineering or manufacturing may be subject to an additional charge. Call for details.

WARRANTY

We warrant that all new products are free from defects in materials and workmanship.* This warranty is effective if products are properly installed and used for the purpose for which they were intended and applies to the original buyer only. Except as set forth above or as set forth in any product-specific warranty documentation, we make no other warranties, express or implied, including, but not limited to, warranties of merchantability or fitness for a particular use.

Returns of a product for warranty must be accompanied by a Return Merchandise Authorization number (RMA#), which can be obtained by calling Customer Service at 866-748-7435, and sent, with freight paid by us. All products returned without an RMA# will be refused. When we issue the RMA#, we will also issue a call tag to have UPS (or other freight company) pick up the product. C.O.D. warranty returns will not be accepted. We will pay no storage charges for a warranty product return prior to pickup by us or the freight company. If a warranty product return is scheduled to be picked up by us, we will pick up the product at our earliest convenience.

If the product returned is found, in our judgment, to be defective in material or workmanship, our obligation under this warranty is limited to the repair or replacement of the product, which will be made by us. Repair or replacement will be at our discretion, with replacements being made using current products performing in the equivalent function. Labor charges, other than those incurred at our factory, including, but not limited to, any labor to install a repaired or replacement product, are not covered under this warranty. All expenses associated with delivering defective products to our factory and delivering repaired or replacement products from our factory to the owner will be paid by us.

If the product returned is found, in our judgment, to be non-warrantable, the owner will be contacted to authorize repair work, the purchase of a replacement product or return of the product, all of which will be at the owner's expense. Payment authorization must be received by us before any non-warrantable product is repaired, replaced or returned. All expenses associated with delivering the repaired non-warrantable product, a replacement product or the non-warrantable product from our factory to the owner will be paid by the owner.

In no event will we be liable for damages of any kind or nature to person, product or property, including, but not limited to, indirect, incidental, special, consequential or punitive damages of any kind, or damages for loss of profits or revenue, even if we have been advised of the possibility of such damages. There are no warranties for used products or products that have been repaired, altered, modified or subjected to misuse, negligence or accident. We will not repair or replace products that fail or malfunction due to ordinary wear and tear, except as expressly provided in a product-specific warranty. The use of non-Shur-Co®, LLC parts in conjunction with Shur-Co®, LLC products will void this product warranty.

*Certain products have specific warranties that differ from this warranty, for example, motors and electronics. Product-specific warranty documentation is available for these items. In the event of a conflict between this warranty and a product-specific warranty, the product-specific warranty will govern.

The Most Comprehensive Line Of Cover Systems In The Transportation Industry!

Agriculture | Construction | Flatbed | Waste

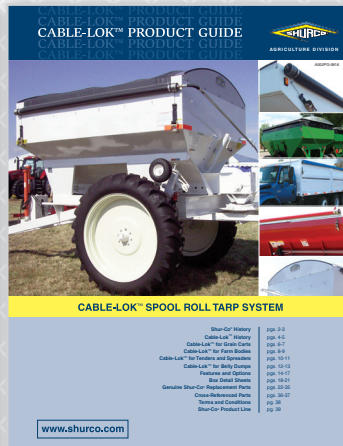
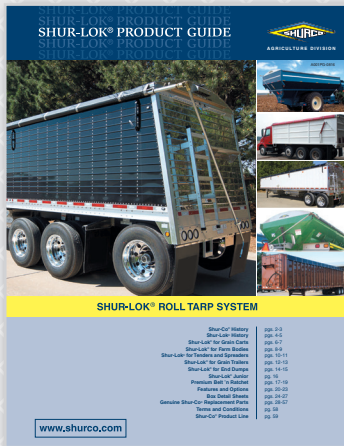

When You Need To Be Sure, Make It Shur-Co®!



www.SHURCO.com